

**MR**

10





1.

1

2

3

4

1.2

1.3

V1.0	2021.11.03	

1.4







### 2.2.3 Ethernet/IP

---

---

---

---

---

---

Ð p





3.

3.1

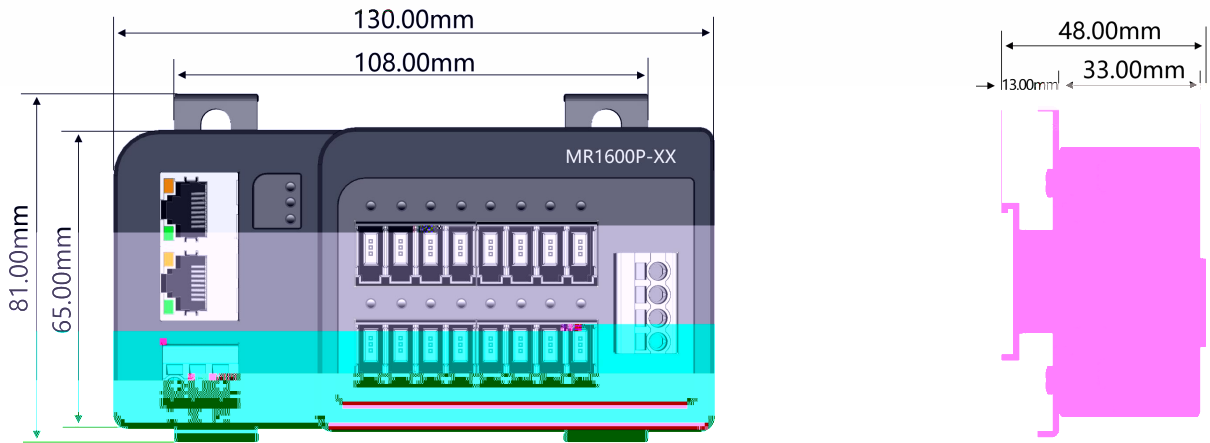

1 130\*81 W/H mm

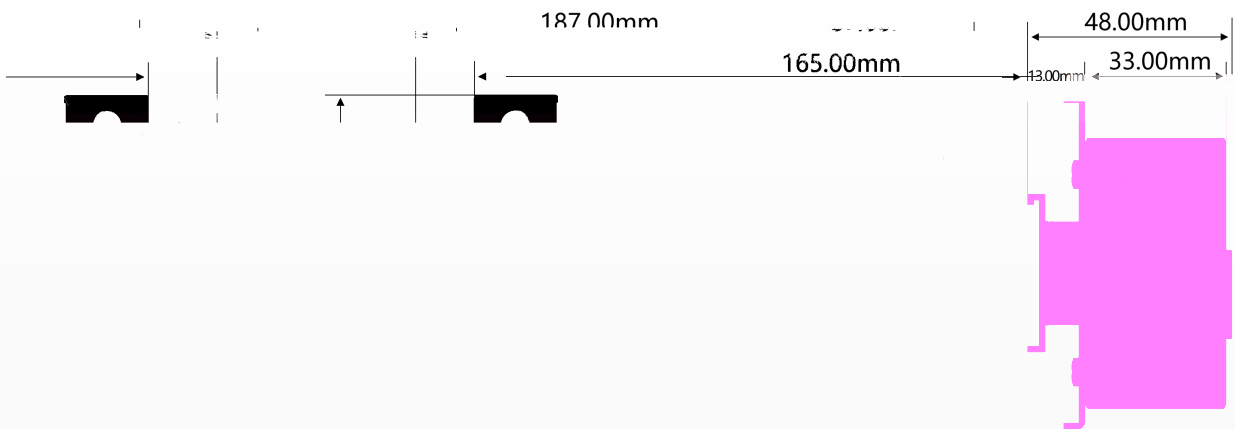

2 187\*81 W/H mm

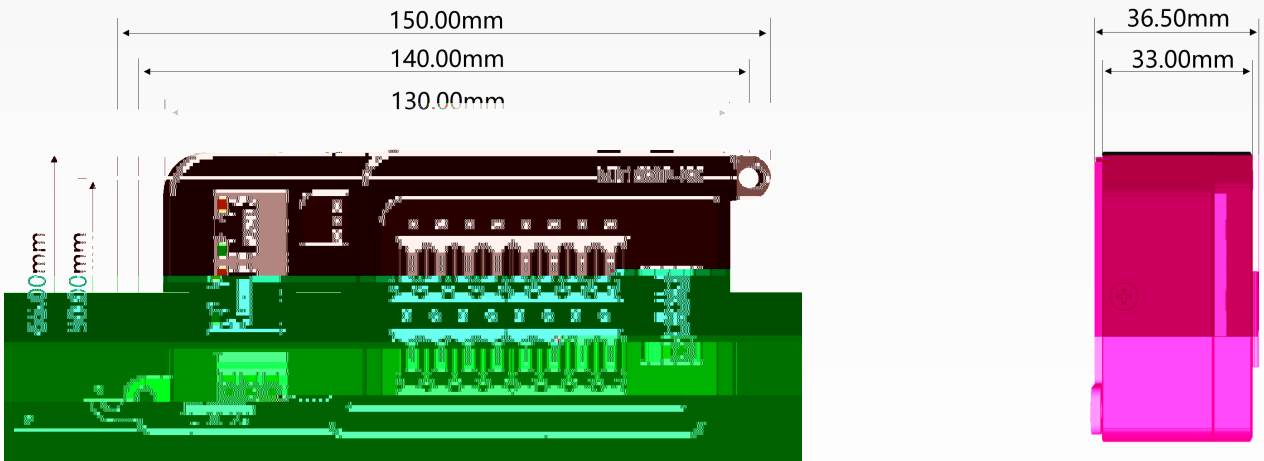

3 150 \*65 W/H mm

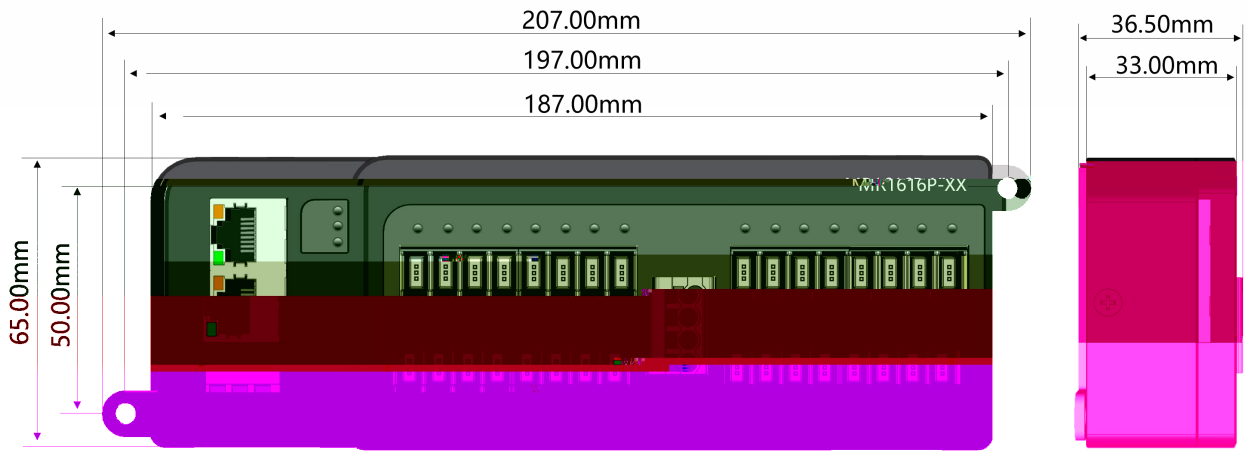

4 1--207 \*65 W/H mm

### 3.2



5 DIN



6



4.

↑  
i

z

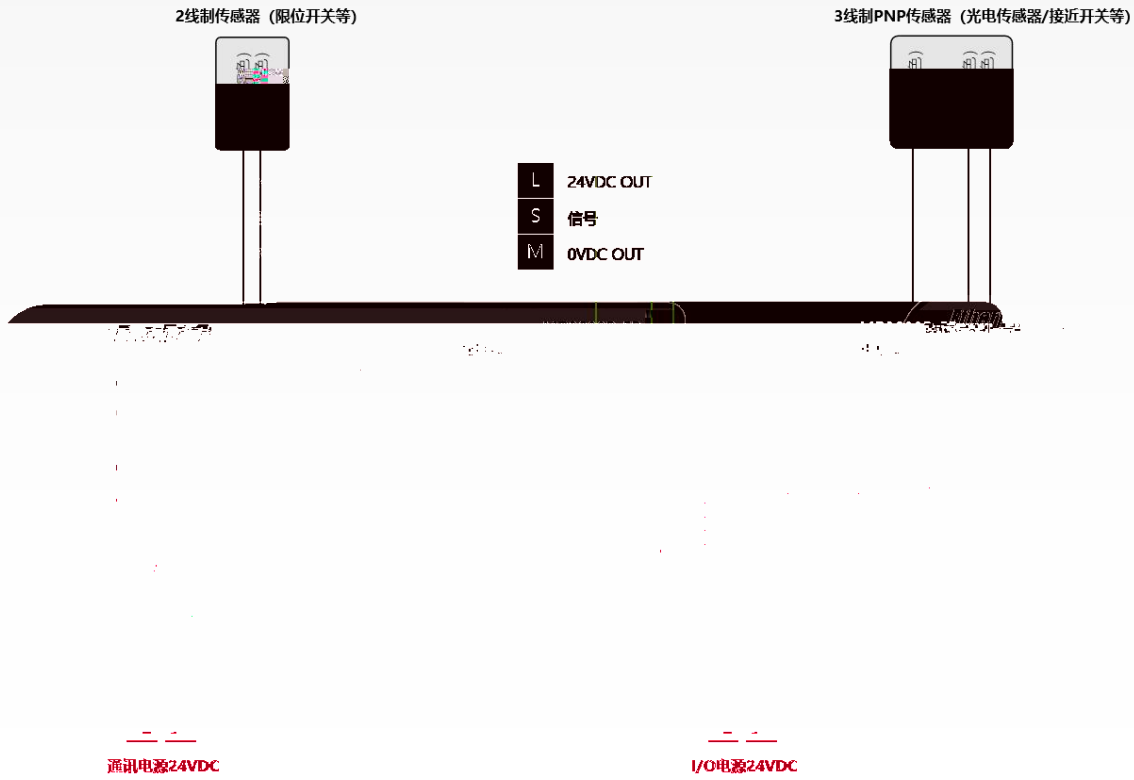

32 PNP

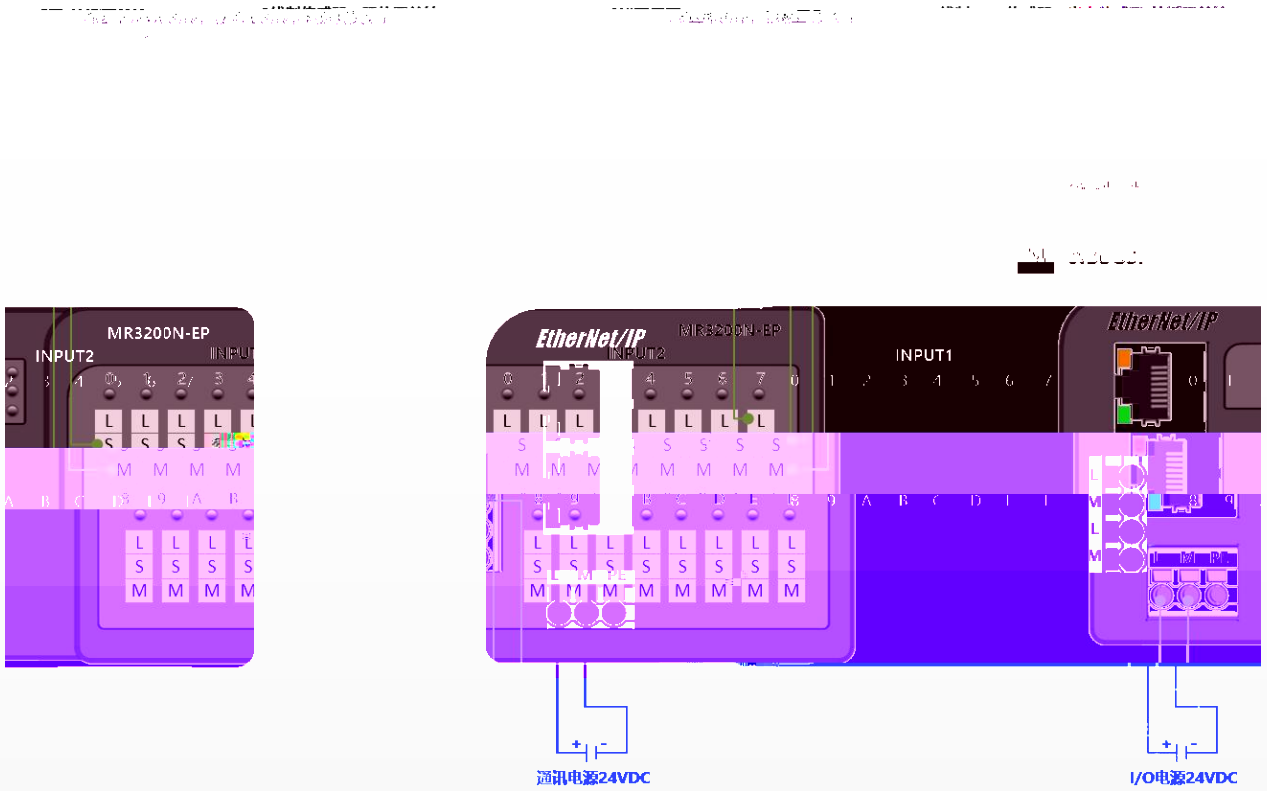

32 NPN



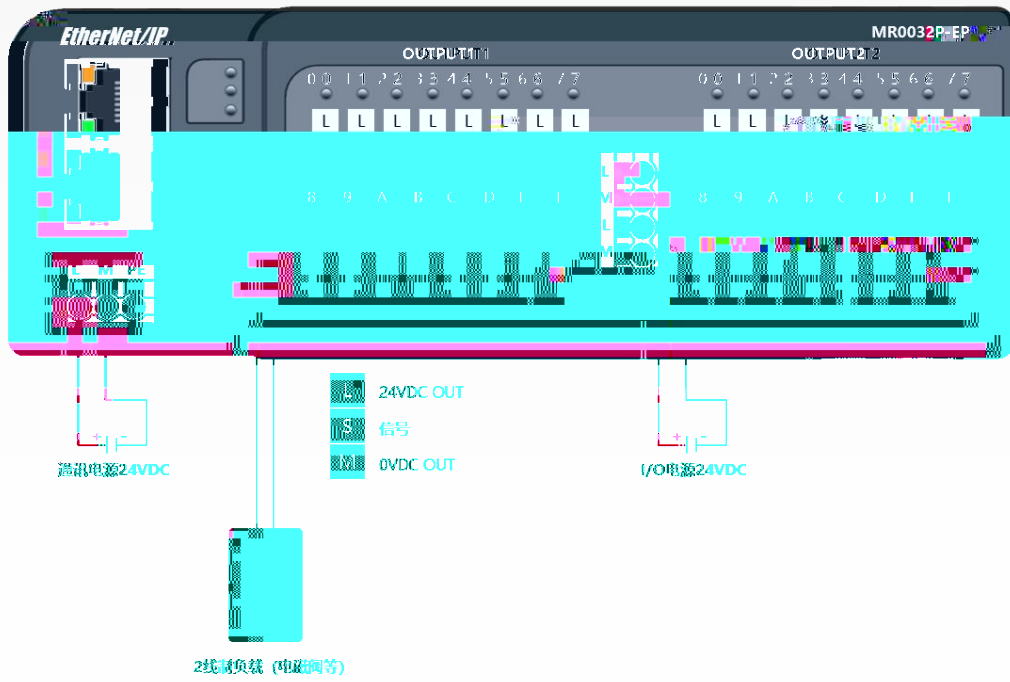

32 PNP

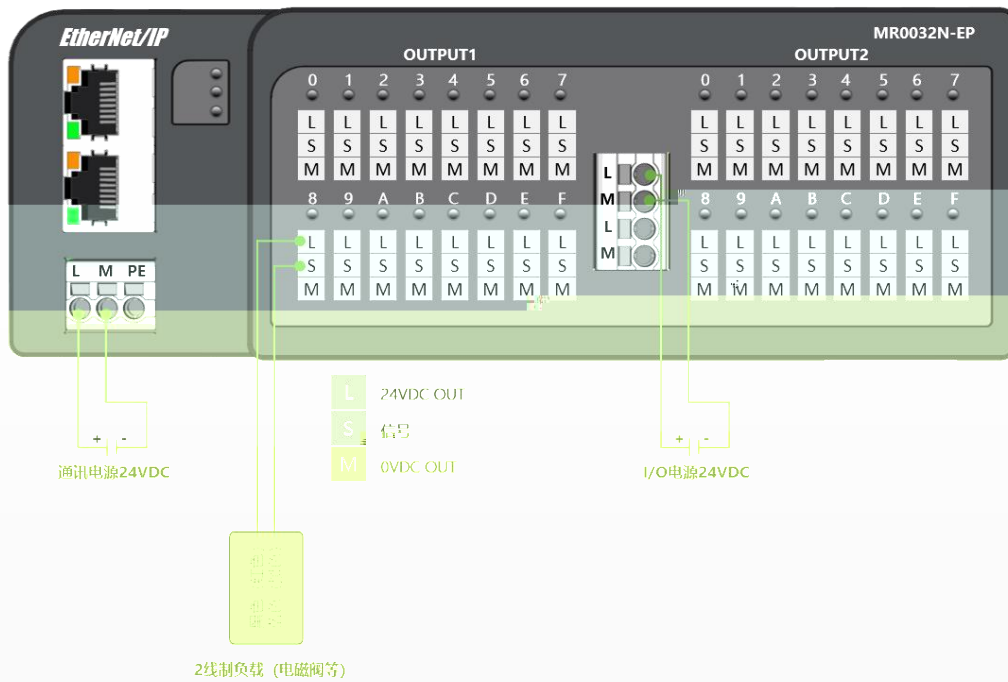

32 NPN



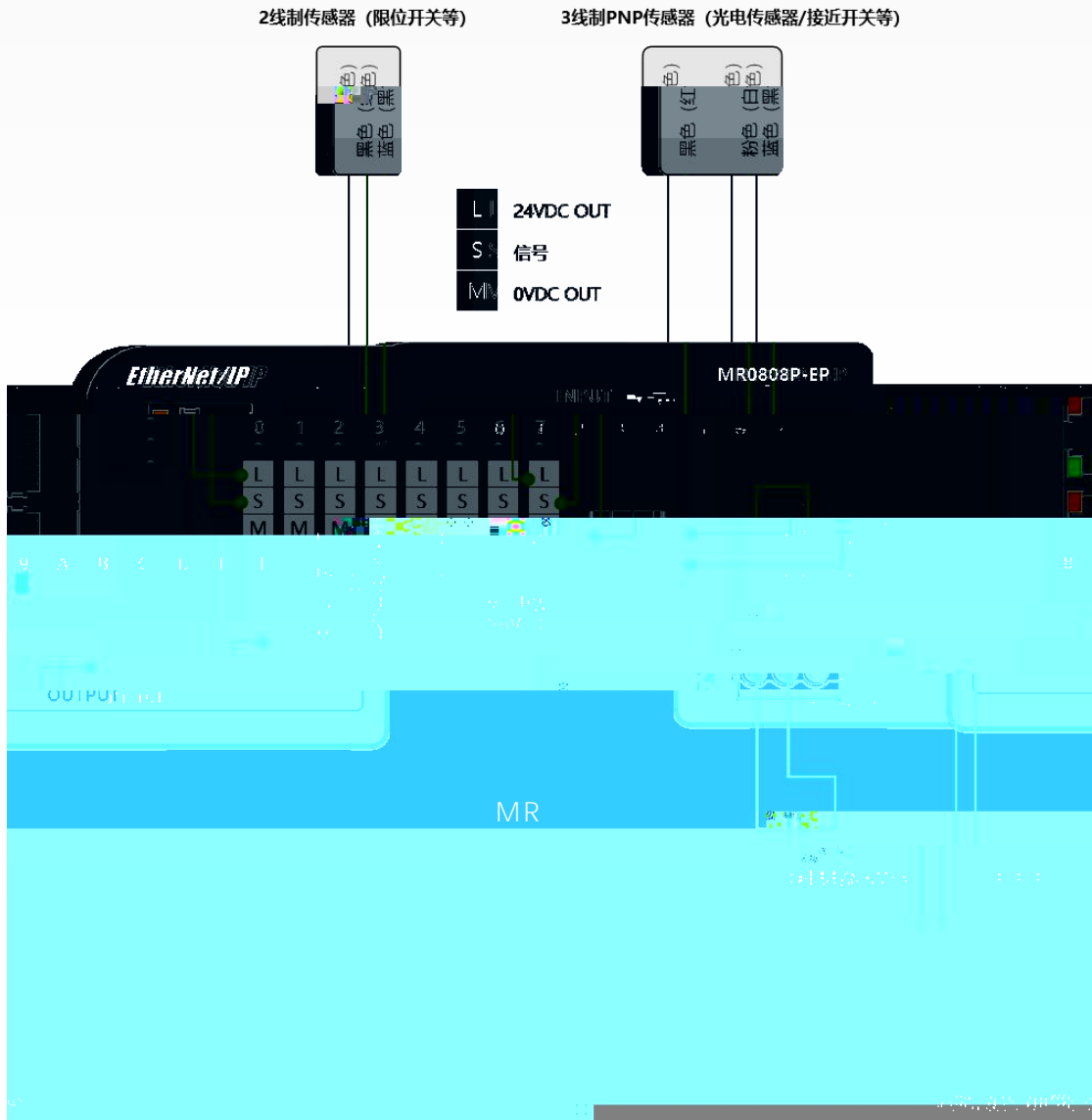

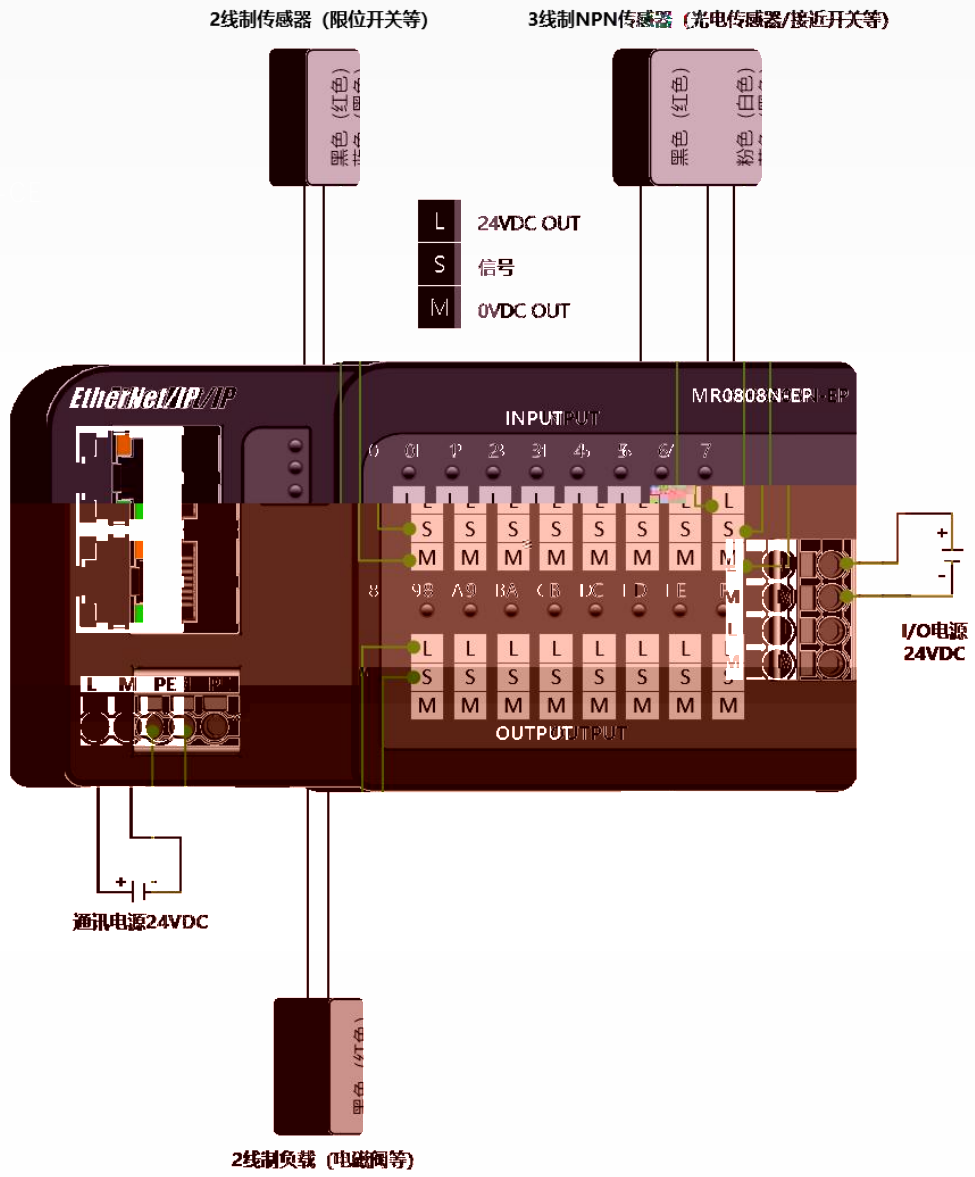

8 8 NPN

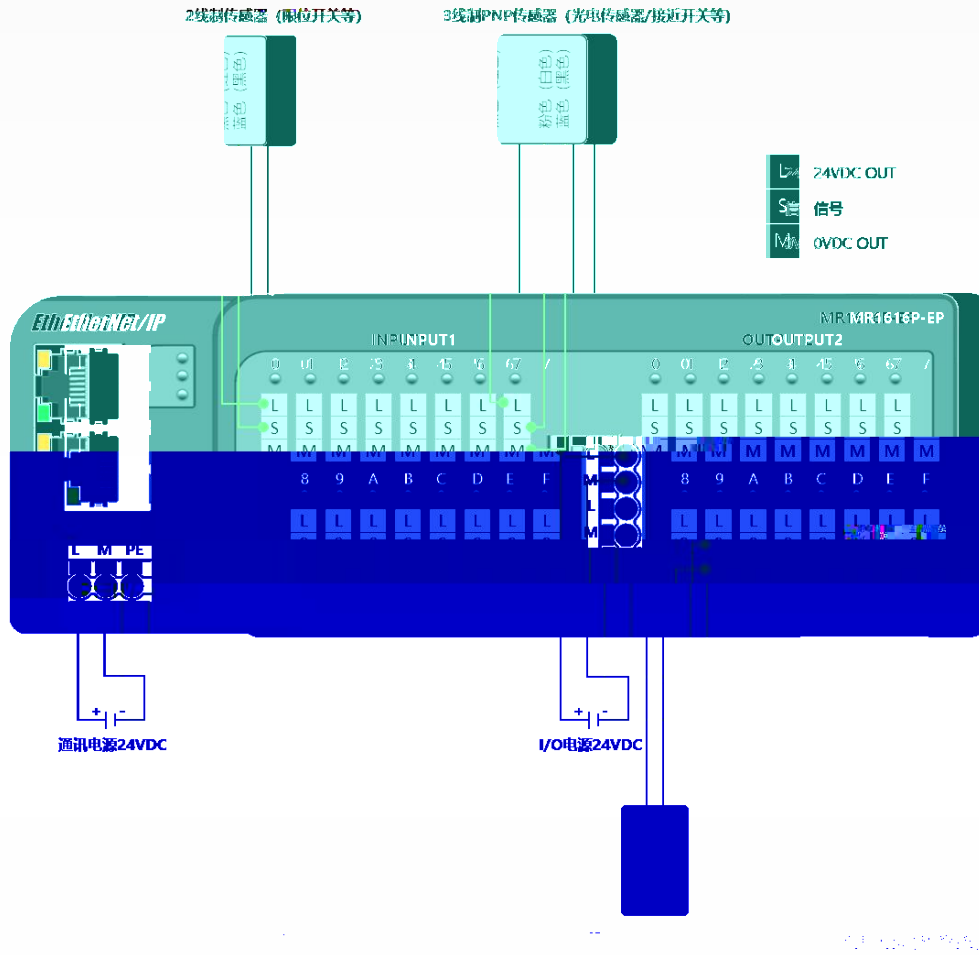

16 16 PNP

2线制传感器 (限位开关等)      3线制NPN传感器 (光电传感器/接近开关等)

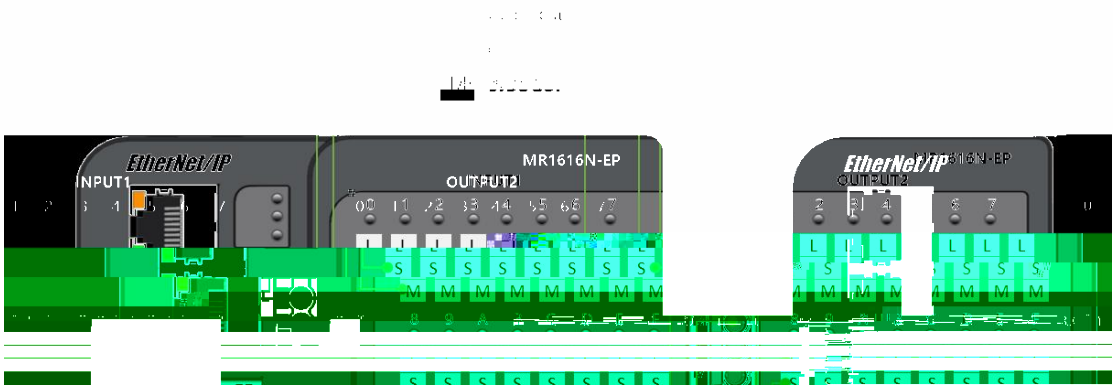

通讯电源24VDC

I/O电源24VDC

2线制负载 (电磁阀等)

16 16 NPN

## 4.2 e-CON

### 4.2.1 e-CON

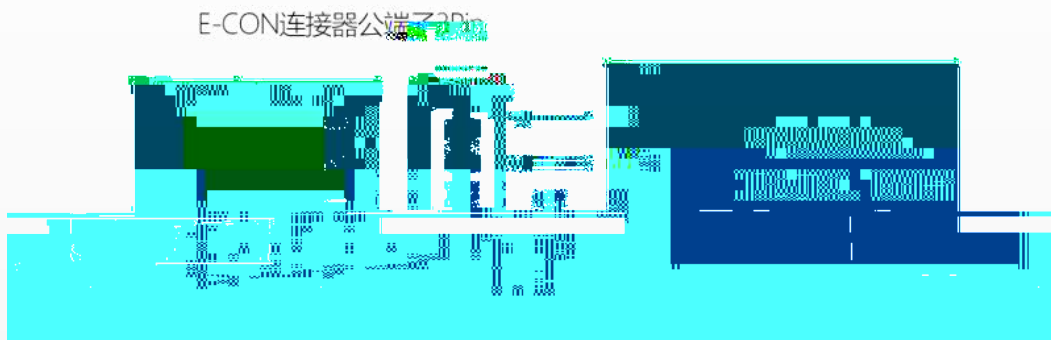
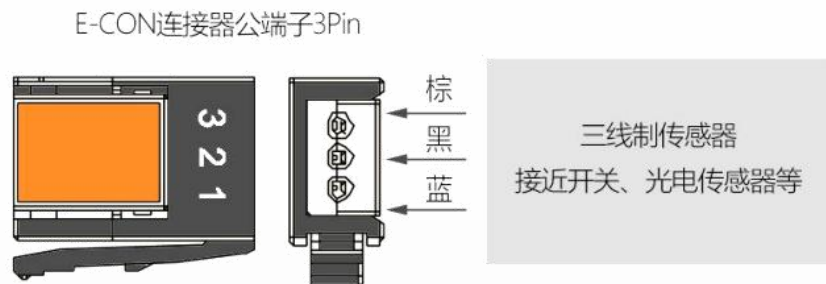
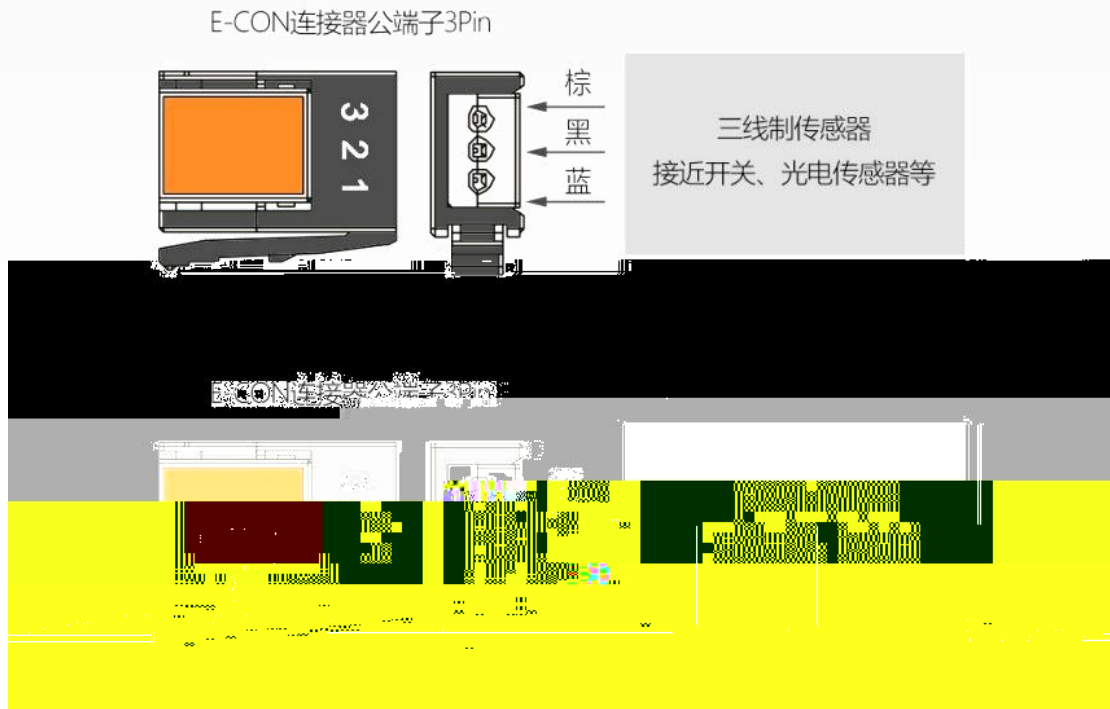

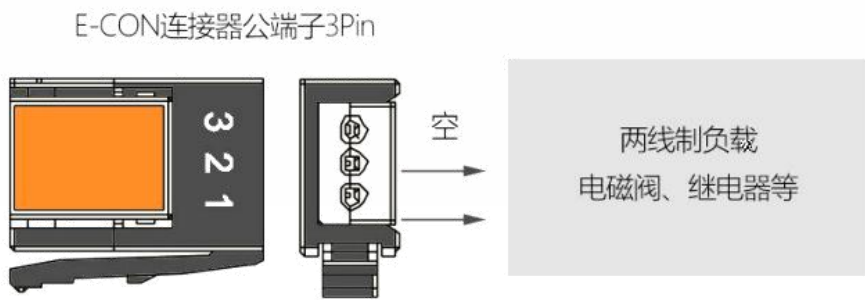

### 4.2.2 e-CON

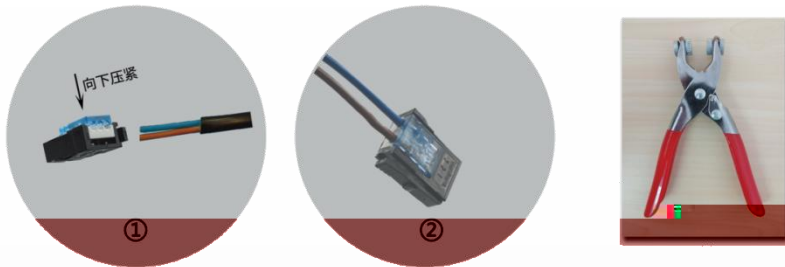

**选择配件时注意**  如选型不匹配将会影响接线效果，导致信号不良，安全隐患重重！

订货号	外观	压盖颜色	电线外径 (mm)	导体规格
EK-03P-VTG		紫色 (灰色外壳)	0.6~0.8	AWG28-26
EK-03P-RDG		红色 (灰色外壳)	0.8~1.0	0.08~0.13mm <sup>2</sup>
EK-03P-VT		紫色	0.6~0.8	
EK-03P-RD		红色	0.8~1.0	AWG26-24
EK-03P-YW		黄色	1.0~1.2	0.13~0.21mm <sup>2</sup>

### 4.3

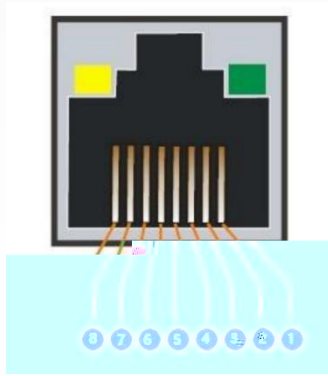

### 5 Ethernet/IP



### 4.4 LED

#### 4.4.1

ERR(	RUN( )	PWR(	

6



#### 4.4.2 I/O

## 4.4.3 RJ45

LINK1/LINK2	ACT1/ACT2	
○		
●		
	○	
	●	

7 RJ45

## 4.5

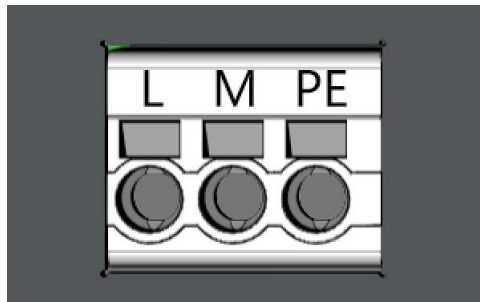

L	
M	
PE	



4.6

4.7





5.



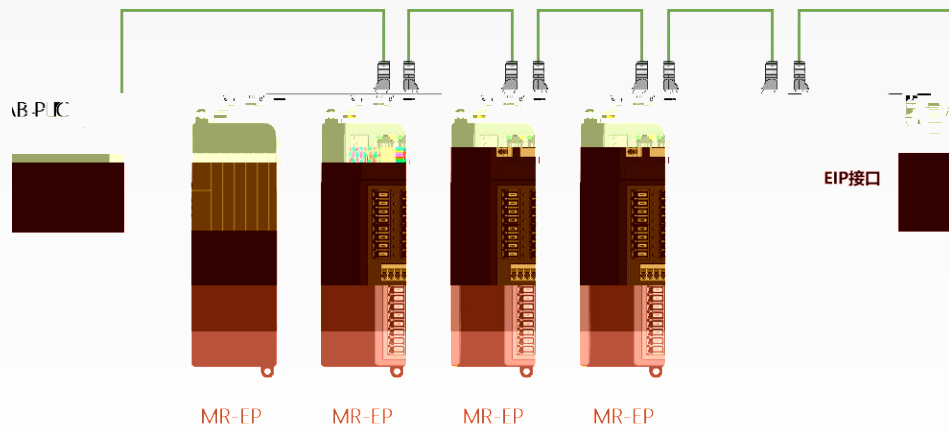

6-2 EtherNet/IP

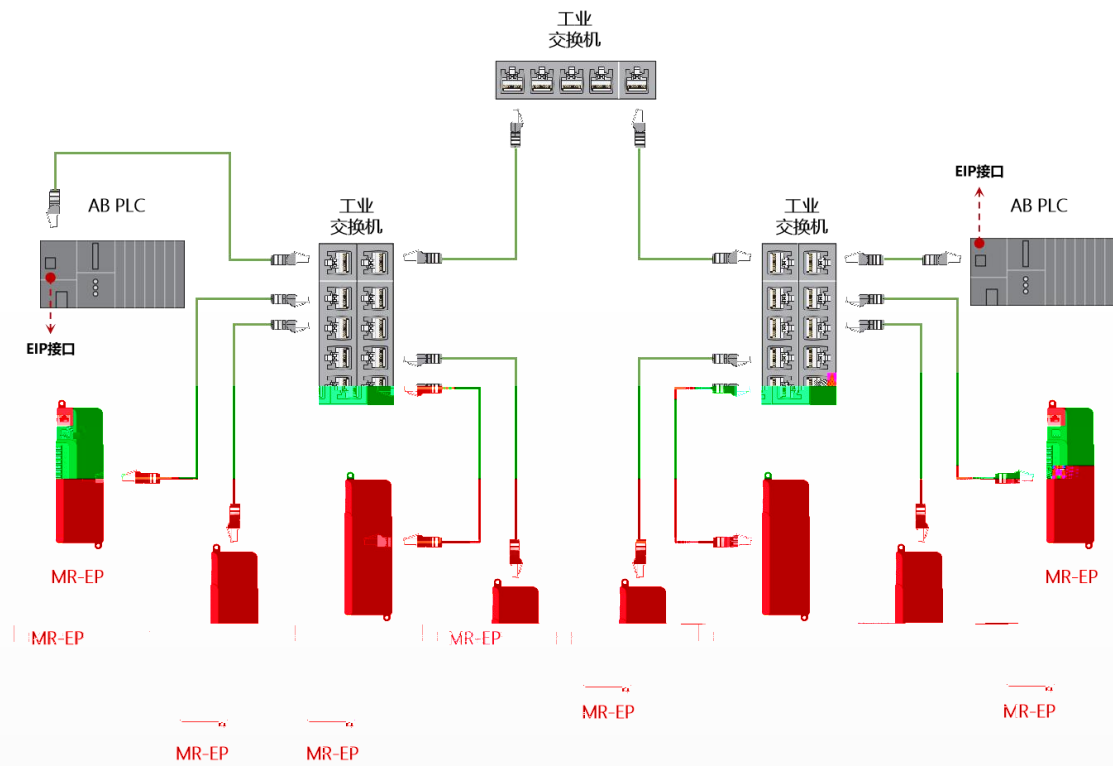

6-3 EtherNet/IP



## MR1600X-EP

MR1600X-EP								

## MR3200X-EP

MR3200X-EP								



MR0808X-EP

