

凌科自动化

User Manual

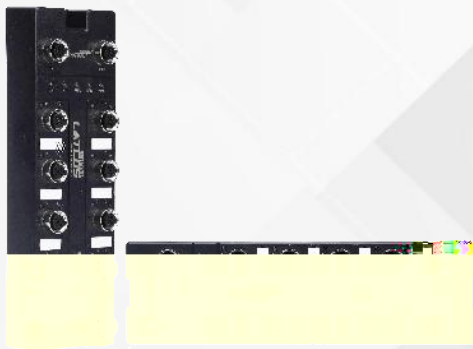

Storm67

PROFINET_RT

ETHERNET/IP

CC-LINK IE FIELD BASIC

ETHERCAT

[Redacted]

[Redacted]

[Redacted]

[Redacted]

[Redacted]

2 m e



- IP67

-

-

-

-

PROFINET EtherCAT EtherNet/IP CC-Link IE Field Basic

-



STM 0808P-PN

(1) (2) (2) (1) (F) (6)

1		STM:STORM67
2	I/O	
3		00:0 08:8 16:16
4		00:0 08:8 16:16
5		P:PNP, N:NPN
6		PN:PEOFINET EA:EtherCAT EP:EtherNet/IP CE:CC-Link IE Field Basic



	24VDC(±25%)			
	16		8	
	8*M12,5PIN,A-Code			
	PNP	NPN	PNP	NPN
"0"	15~ 30V	-3~ +3V	15~ 30V	-3~ +3V
"1"	-3~ +3V	15~ 30V	-3~ +3V	15~ 0V
	3ms			
	4mA			
	MAX:2A (From UL)			
	500V			
	LED			
	24VDC(±25%)			
	16		8	
	8*M12,5PIN,A-Code			
	PNP	NPN	PNP	NPN
	MAX:500mA (From UL)			
	MAX:4A (From UL)		MAX:8A (From UL)	
	500V			
	LED			





图 1-1-1

图 1-1-2

图 1-1-3

图 1-1-4

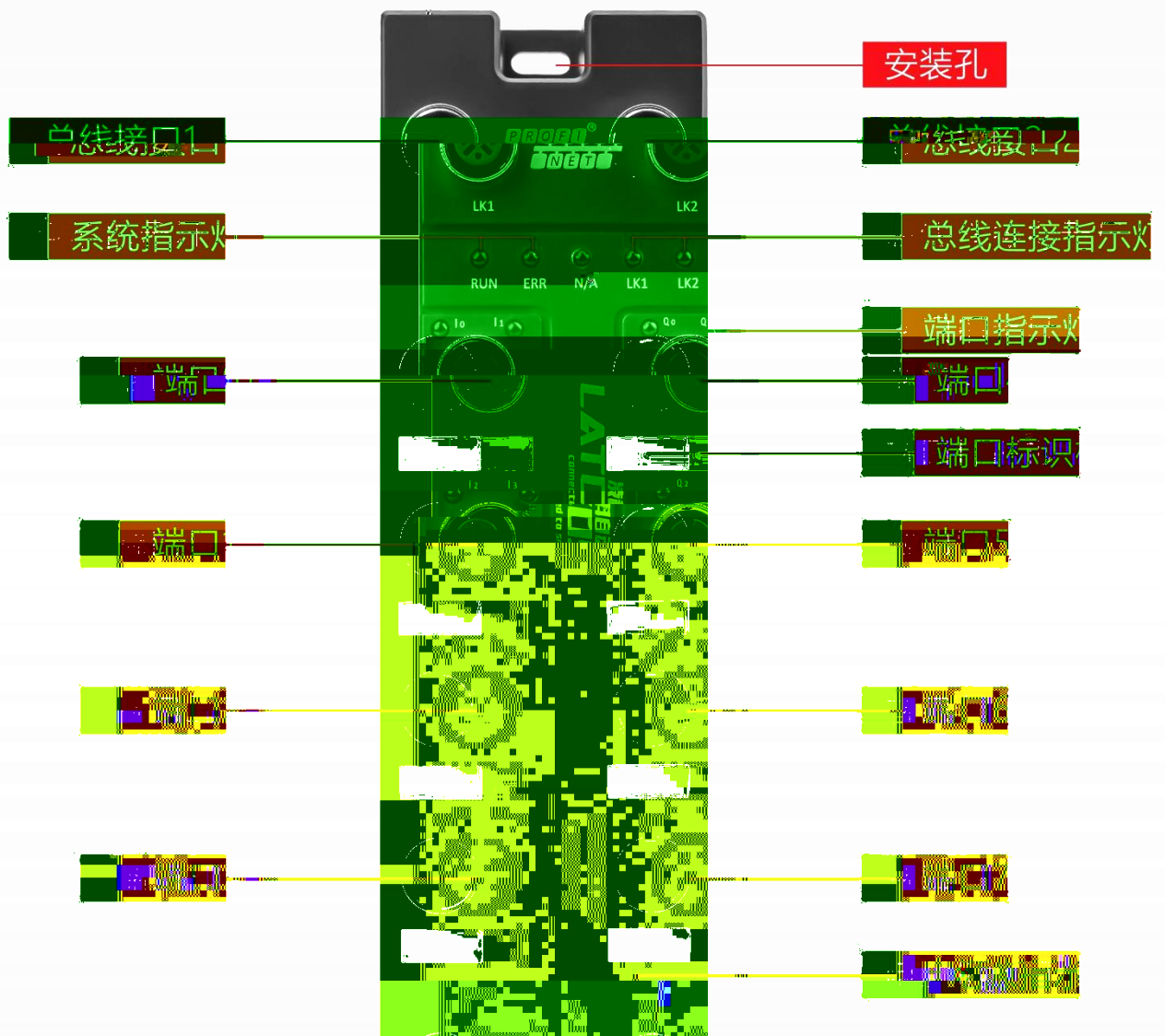
图 1-1-5

图 1-1-6

图 1-1-7

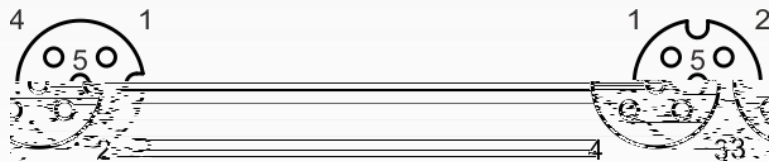

1	UL+	+24V	
2	DI/DO B	/ B	
3	UL-	0V	
4	DI/DO A	/ A	
5	PE	PE	



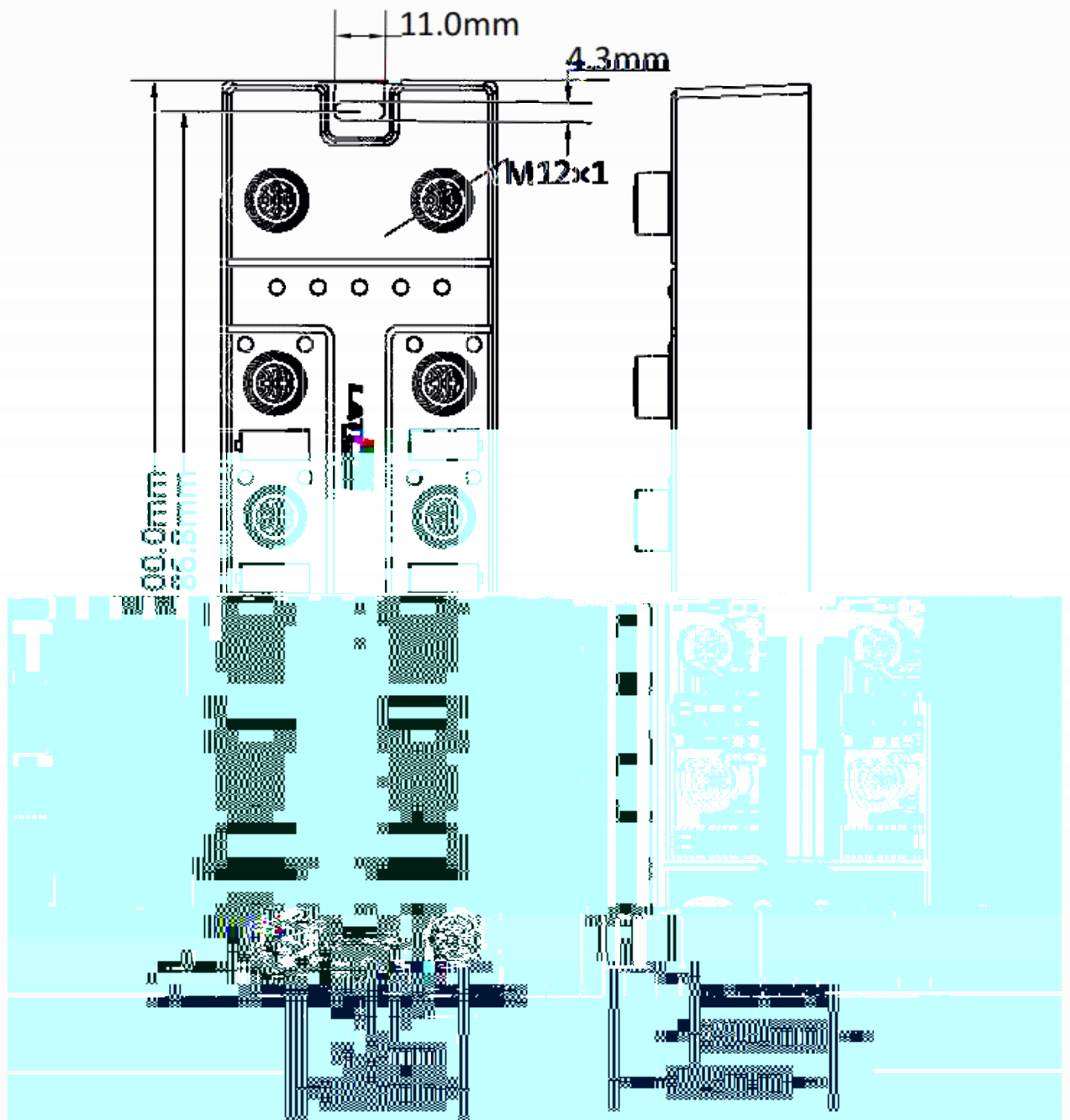

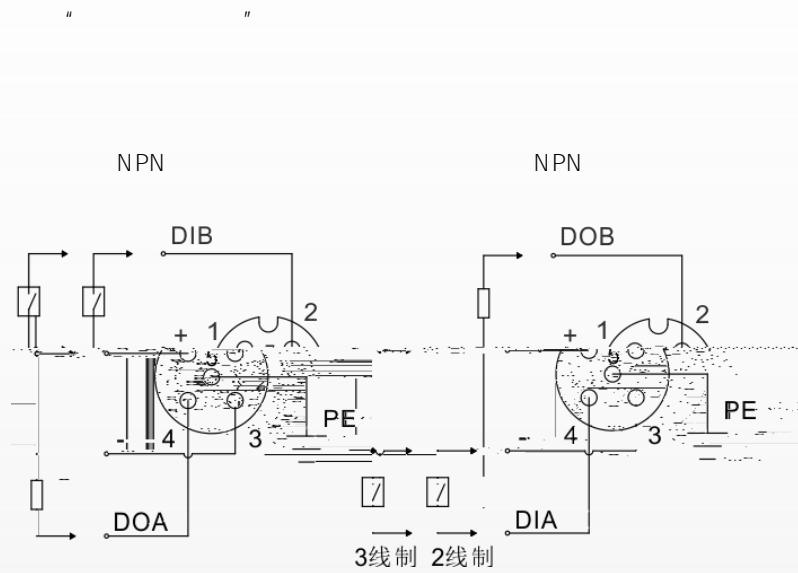
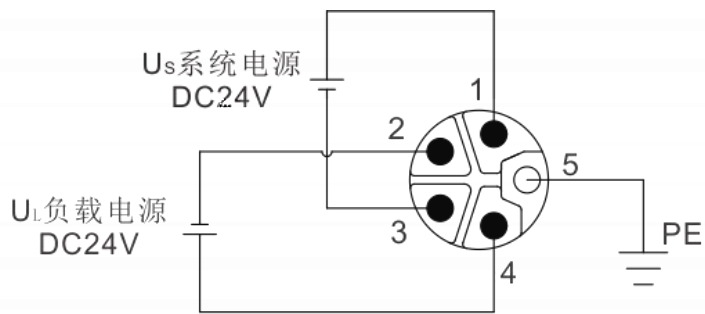

PNP
DIR

PNP
NOR

IP67

EN61131-2, 2

STM0808P-PN S7-1211C DC/DC/DC PC TIA V1
4 "STM-PN"

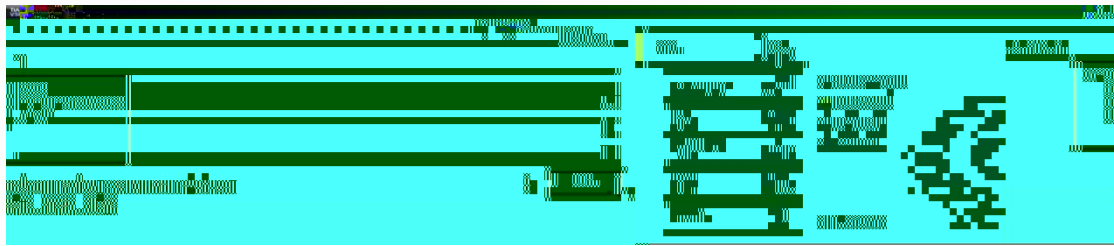

PLC STM-PN " "
PLC S7-1211C DC/DC/DC,

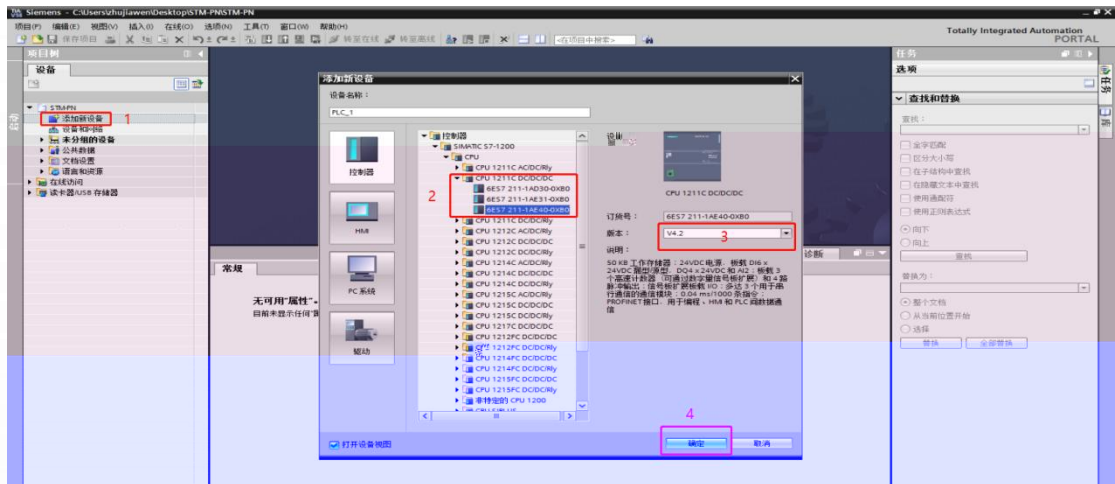

“ ”
GSD

GSD”，

LUC-PNx GSD

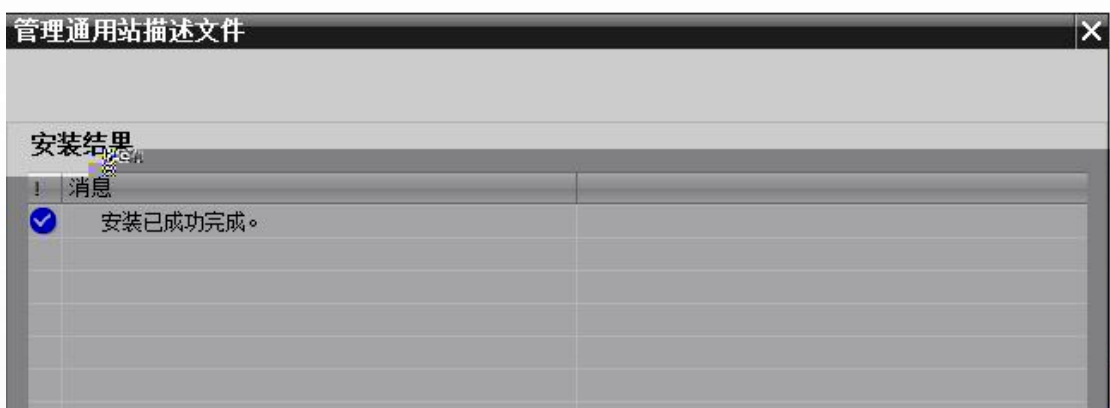
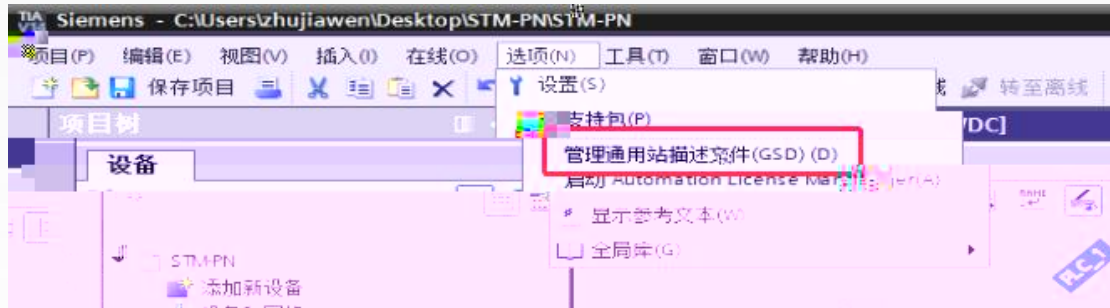

PLC

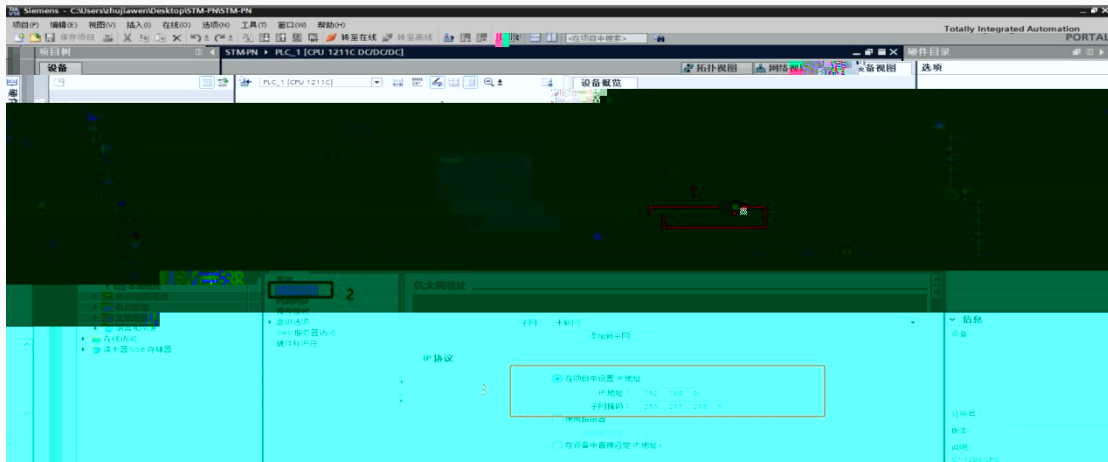

STM0808X-PN
PROFINET IO-System"

"PLC_1.

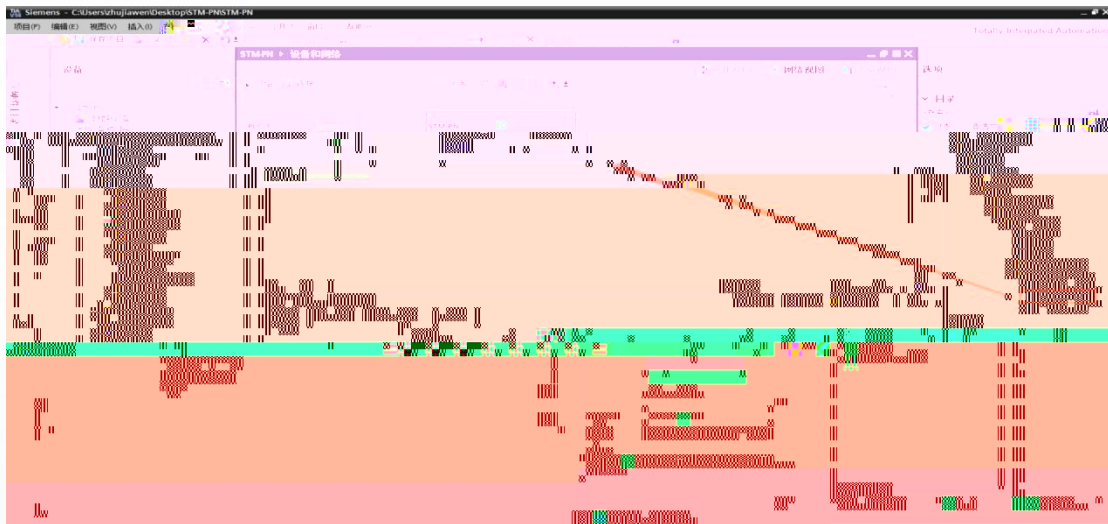

“ PLC_1.PROFINET _1” STM0808X-PN
 “PLC_1. PROFINET IO-System”

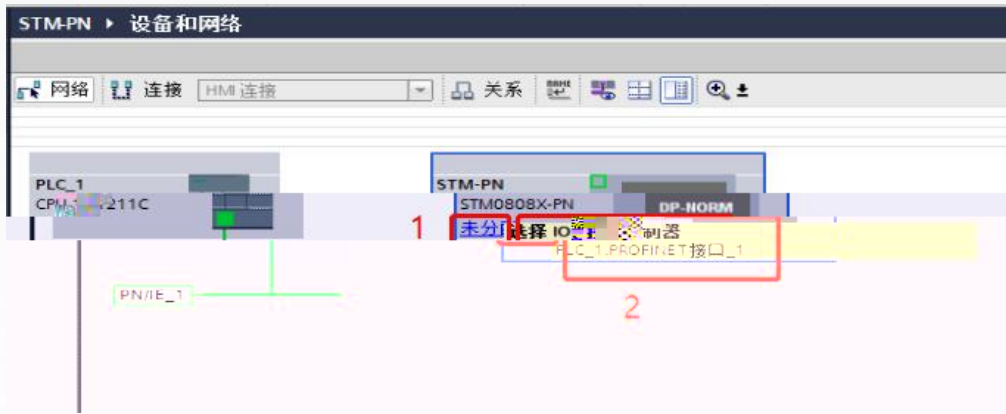

IO

IP 192.168.0.2

PROFINET

“STM-PN”

网络接口 [Interface]

常规 IO 变量 系统常数 文本

以太网地址

接口连接到

子网: PNIE_1

IP 协议

IP 地址: 192.168.0.2

子网掩码: 255.255.255.0

PROFINET

自动生成 PROFINET 设备名称

PROFINET 设备名称: stm-pn

转换的名称: stm-pn

设备编号: 1

MAC

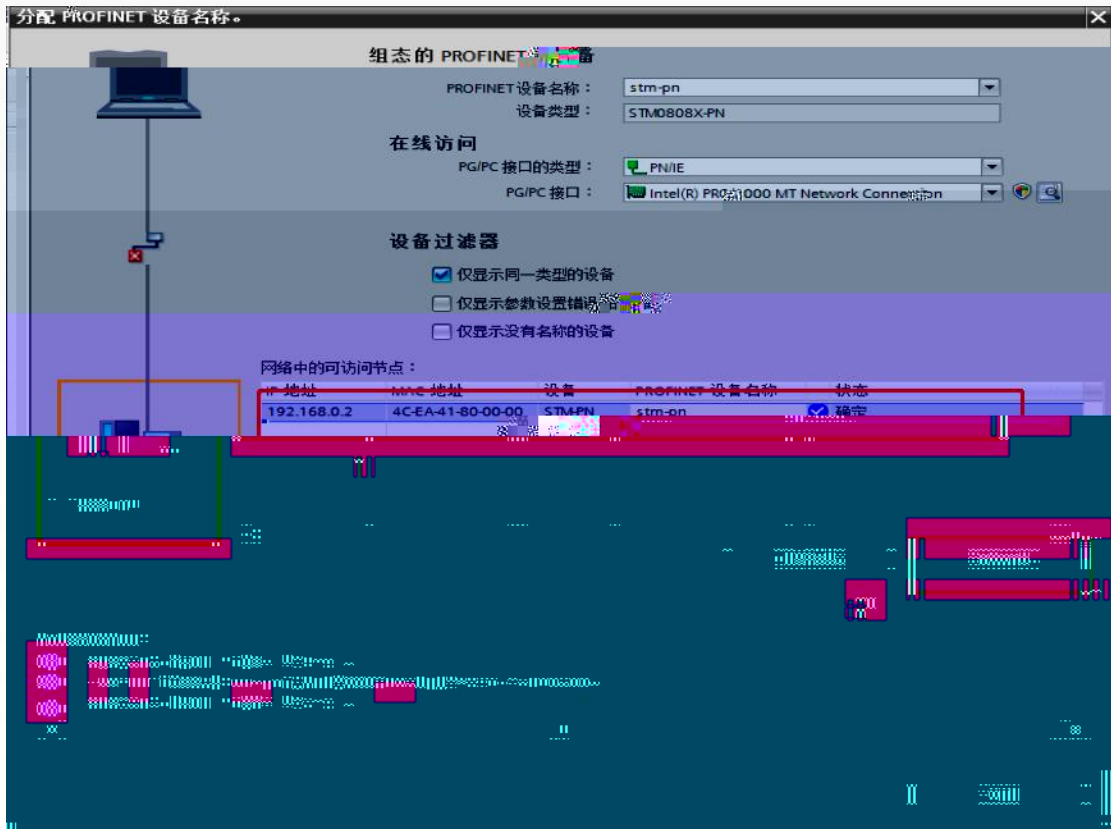

PLC

IP

plc

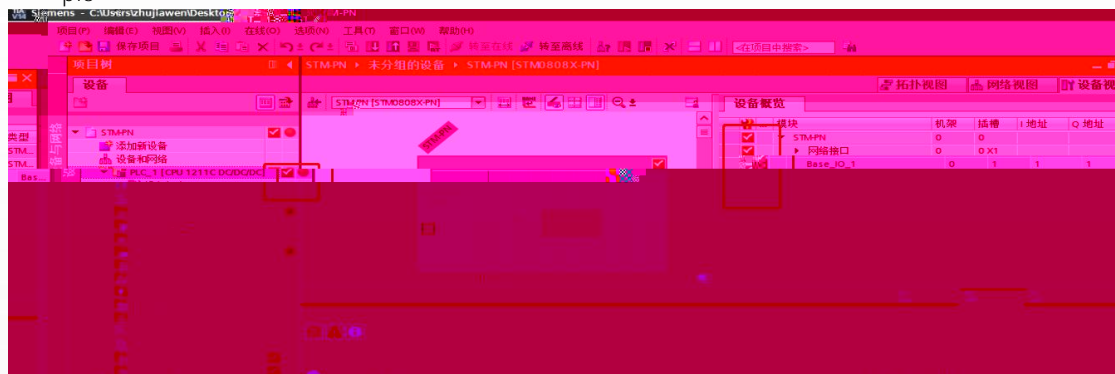



Copyright © 2023Wuxi Latcos Automation Technology, Inc. All rights reserved.

www.latcos.cn